



Shanghai Miyue
Semiconductors Co.,Ltd
Tel:0086-21-57159233
Fax:0086-21-60415325

SF21 THRU SF28

Features

- Lead Free Finish/Rohs Compliant (Note1) ("P" Suffix designates Compliant. See ordering information)
- Low forward voltage drop
- Epoxy meets UL 94 V-0 flammability rating
- Moisture Sensitivity Level 1
- Marking: Type Number

Maximum Ratings

- Operating Temperature: -55°C to +125°C
- Storage Temperature: -55°C to +150°C
- For capacitive load, derate current by 20%

Part Number	Maximum Recurrent Peak Reverse Voltage	Maximum RMS Voltage	Maximum DC Blocking Voltage
SF21	50V	35V	50V
SF22	100V	70V	100V
SF23	150V	105V	150V
SF24	200V	140V	200V
SF25	300V	210V	300V
SF26	400V	280V	400V
SF28	600V	420V	600V

2.0 Amp Super Fast Rectifier 50 to 600 Volts

DO-15

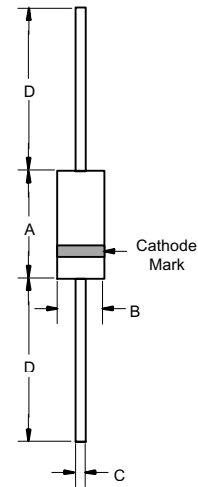

Electrical Characteristics @ 25°C Unless Otherwise Specified

Average Forward Current	$I_{F(AV)}$	2.0A	$T_C = 55^\circ\text{C}$
Peak Forward Surge Current	I_{FSM}	50A	8.3ms, half sine
Maximum Instantaneous Forward Voltage SF21-SF24 SF25-SF26 SF28	V_F	0.95V 1.30V 1.70V	$I_{FM} = 2.0A$; $T_a = 25^\circ\text{C}^*$
Maximum DC Reverse Current At Rated DC Blocking Voltage	I_R	5.0uA 100uA	$T_C = 25^\circ\text{C}$ $T_C = 100^\circ\text{C}$
Typical Junction Capacitance SF21-SF24 SF25-SF28	C_J	60pF 30pF	Measured at 1.0MHz, $V_R=4.0V$
Maximum Reverse Recovery Time	T_{RR}	35nS	$I_F=0.5A$, $I_R=1.0A$, $I_{RR}=0.25A$

*Pulse Test: Pulse width 300 usec, Duty cycle 1%.

Note: 1. High Temperature Solder Exemptions Applied, see EU Directive Annex 7.

DIM	INCHES		MM		NOTE
	MIN	MAX	MIN	MAX	
A	.230	.300	5.80	7.60	
B	.104	.140	2.60	3.60	
C	.026	.034	.70	.90	
D	1.000	---	25.40	---	

SF21 thru SF28

FIG.1- TYPICAL REVERSE CHARACTERISTICS

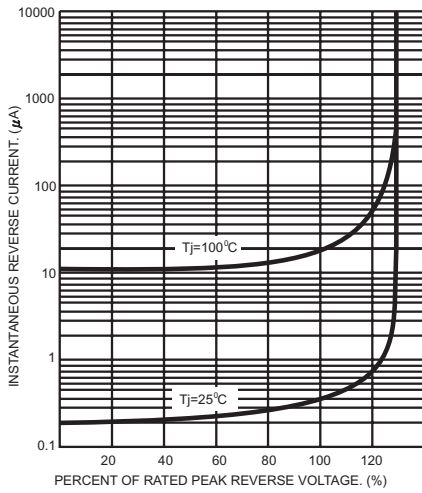

FIG.2- TYPICAL FORWARD CHARACTERISTICS

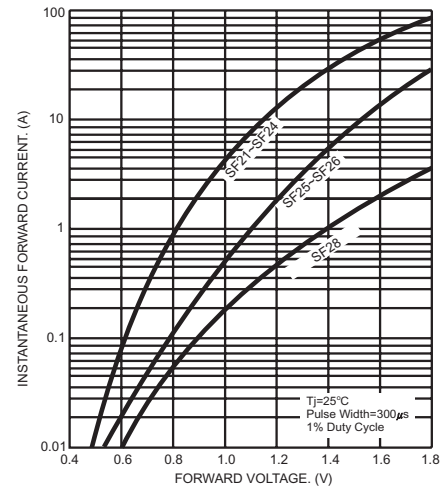
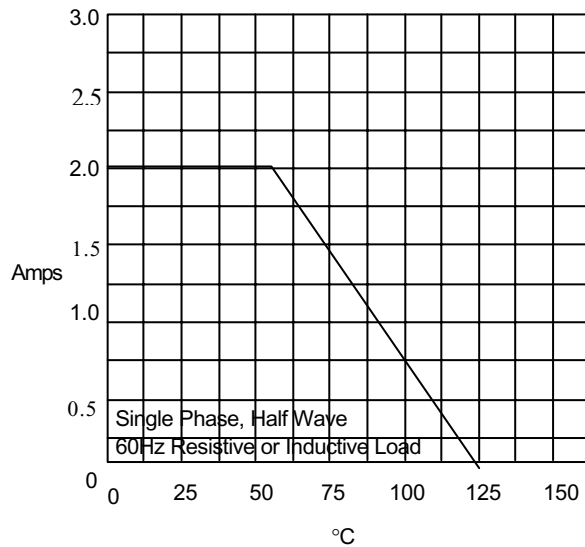

Figure 3
Forward Derating Curve



Average Forward Rectified Current Per Leg - Amperes versus Case Temperature - °C

SF21 thru SF28

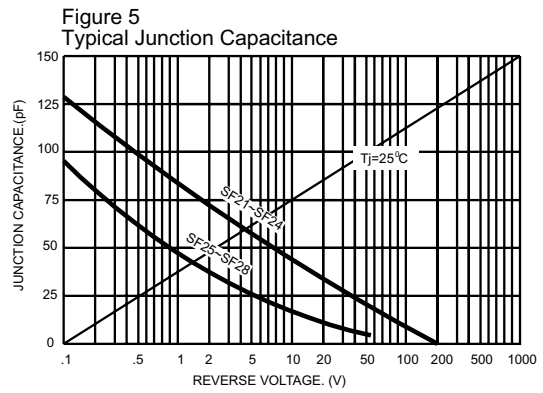
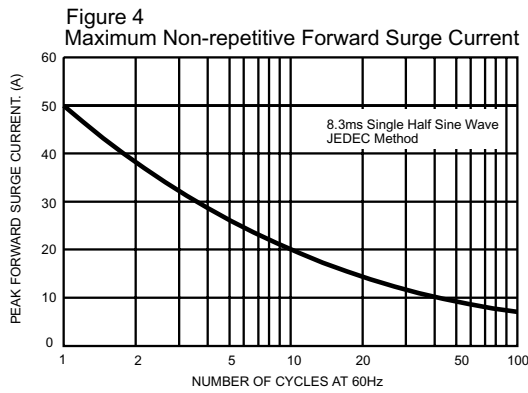
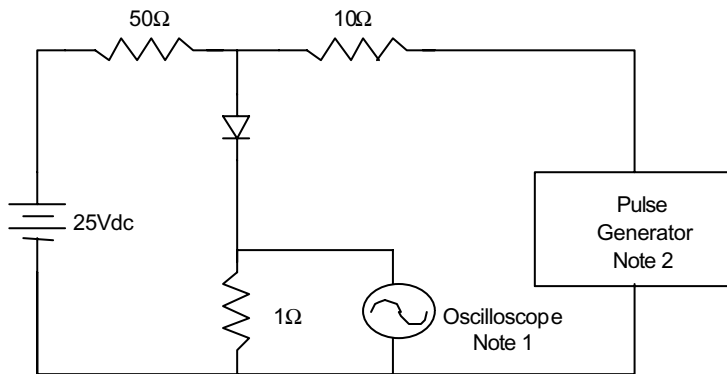

Figure 6
Reverse Recovery Time Characteristic And Test Circuit Diagram



- Notes:
1. Rise Time = 7ns max.
Input impedance = 1 megohm, 22pF
 2. Rise Time = 10ns max.
Source impedance = 50 ohms
 3. Resistors are non-inductive

